

Bellari

RP583 Studio Tube Compressor/Limiter

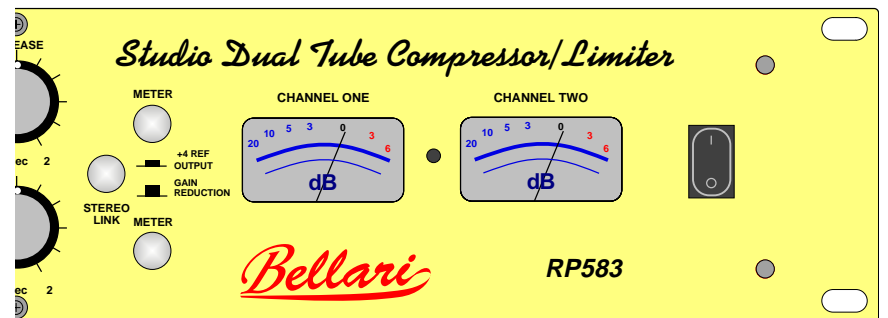
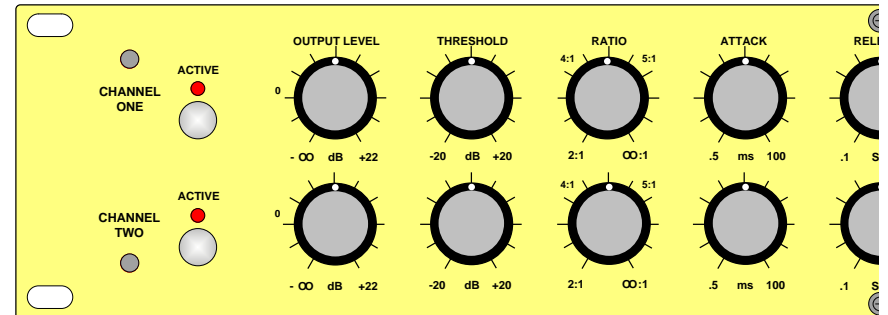

Bellari
Salt Lake City, UT

OWNERS MANUAL

OPERATION

THE FOLLOWING SETTINGS ARE APPROXIMATE, AND LISTED AS SUGGESTIONS ONLY.

VOCAL COMPRESSION

The most effective way to connect your RP583 for vocal compression is by patching it into a channel insert of your mixing board. Connect the Input of the RP583 to the send, and the RP583 Output to the return. You may need a special cable to accomplish this, consult your mixer owner's manual.

Set the level to the Compressor by speaking or singing into the microphone at the same level that it will be used during performance. Set the Meter switch to Output, and adjust the gain control on your mixer so the RP583 meter moves to approximately 0.

Press in the Active button to put the RP583 in compression mode. See diagram below for settings.

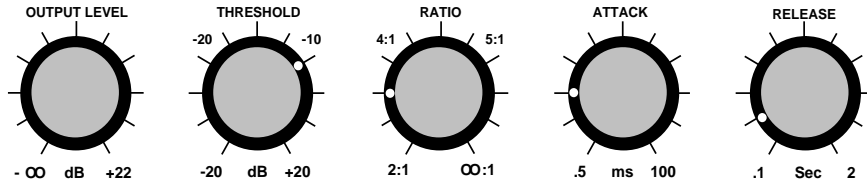

DRUM COMPRESSION

The RP583 may be used to compress various drum parts for a smooth, tight drum sound as well as more control over a final mix. Connect your RP583 to the insert of your mixer and set the input level as directed above. Shown below is an example of a typical drum compression setting.

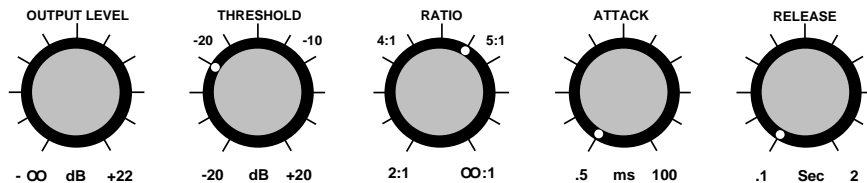

PROGRAM COMPRESSION

Shown below is a setting example for entire program compression, used for example to limit a final mixdown.

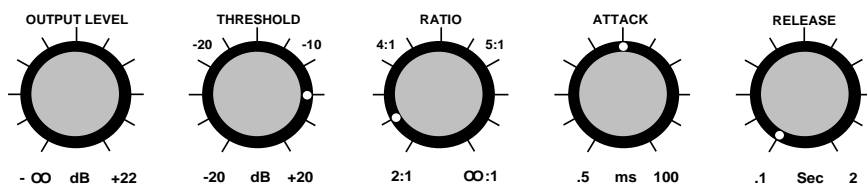

Congratulations on choosing the Bellari RP583 Studio Tube Compressor/Limiter. We recommend that you take a moment and read this manual as it provides information that will help you in using your unit to its fullest potential. The RP583 provides smooth, natural compression and clear sonic quality and performance for the working musician, studio operator or anyone who needs a comp/limiter with the warm, smooth, analog sound. Each channel uses one *Bellari* premium 7025 tube in a unique configuration to give superior signal control. The unit has both XLR and 1/4" inputs and outputs. Plus it has a Side Chain input and output for each channel, for direct access to the detector circuits.

INSPECTION

1. Unpack and Inspect the RP583 package

Your RP583 was carefully packed at the factory in a protective carton. Nonetheless, be sure to examine the unit and the carton for any signs of damage that may have occurred during shipping. If obvious physical damage is noticed, contact the carrier immediately to make a damage claim. We suggest saving the shipping carton and packing materials for safely transporting the unit in the future.

2. Please complete the Warranty Registration Card and return it to the factory.

BLOCK DIAGRAM

Note: The diagram shown is for both Channel One and Two.

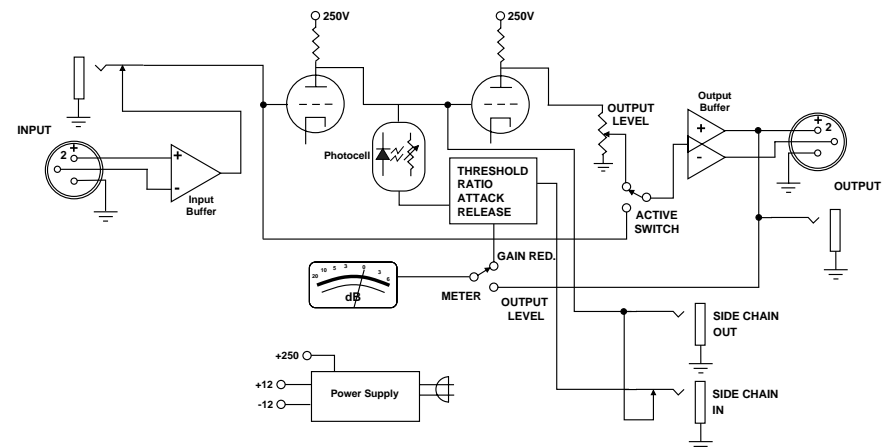

FRONT PANEL DESCRIPTION

Note: Channel One descriptions are identical to Channel Two

Active Switch: Engages and disengages the compression.

Output Level: Varies the overall signal level from the RP583.

Threshold: Sets the level at which the income signal must overcome in order for the RP583 to begin compressing.

Ratio: The signal to compression ratio - sets the amount of increase in input signal required to raise the output signal 1 dB.

Attack: Varies the amount of time taken for the RP583 to begin compressing once the Threshold level has been reached.

Release: Varies the amount of time taken for the RP583 to return to normal gain once the signal has dropped below the Threshold level.

Stereo Link Switch: Links the detector circuits of both channels together. *NOTE: CHANNEL TWO BECOMES THE MASTER CHANNEL.*

Meter Switch: Switches the signal metering from indicating the output jack level, to indicating the amount of gain reduction.

VU Meter: Indicates either the output signal level, or the amount of gain reduction, depending on the position of the Meter Switch.

NOTE: THE INPUT SIGNAL LEVEL MAY ALSO BE METERED BY PRESSING OUT THE ACTIVE SWITCH, THUS BYPASSING THE COMPRESSOR CIRCUITS.

Power Switch: Turns the RP583 main power on and off.

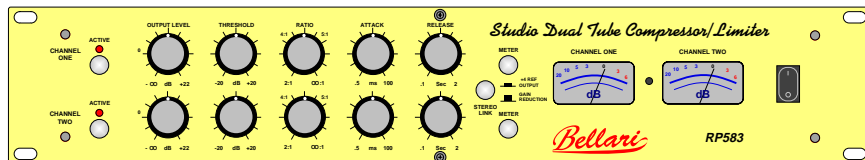

REAR PANEL DESCRIPTION

Note: Channel One descriptions are identical to Channel Two

Outputs: XLR balanced and 1/4" unbalanced connectors for connecting the RP583 to a mixer or other line level input.

Side Chain Input: 1/4" unbalanced jack for receiving incoming signals to directly access the detector circuit of the compressor.

Side Chain Output: 1/4" unbalanced jack for sending out the signal from the RP583. This jack may also be used as a pre-Output Level output.

Note: The Side Chain Inputs and Outputs are not effects loops, they break the signal path of the RP583 control circuits.

Inputs: XLR balanced and 1/4" unbalanced connectors for connecting line level signals to the RP583.

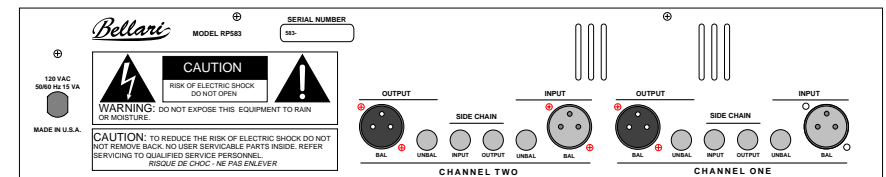

SPECIFICATIONS

Frequency Response	20 Hz - 40 kHz
Input Impedance	10K Ω balanced 1M Ω unbalanced
THD + Noise	<0.1% typical
S/N Ratio	90 dB
Indicators	2: Active LEDs 2: Analog Meters
Input/Output jacks	XLR balanced 1/4" unbalanced
Side Chain:	1/4" unbalanced
Dimensions	3.5" x 6" x 19" (89mm X 162mm X 482mm)
Weight	6 lbs. (2.72 Kg)
Power	120VAC (230VAC) 15VA

TABLE OF CONTENTS

Introduction	1
Inspection	
Block Diagram	
Front Panel Description	2
Rear Panel Description	3
Specifications	3
Operation	4
Vocal Compression Example	
Drum Compression Example	
Program Comp. Example	
Warranty	5

LIMITED WARRANTY

This product is warranted to the original consumer purchaser to be free from defects in materials and workmanship under normal installation, use and service for a period of one (1) year from the date of purchase as shown on the purchaser's receipt.

The obligation of Rolls Corporation under this warranty shall be limited to repair or replacement (at our option), during the warranty period of any part which proves defective in material or workmanship under normal installation, use and service, provided the product is returned to Rolls Corporation, TRANSPORTATION CHARGES PREPAID. Products returned to us or to an authorized Service Center must be accompanied by a copy of the purchase receipt. In the absence of such purchase receipt, the warranty period shall be one (1) year from the date of manufacture.

This warranty shall be invalid if the product is damaged as a result of defacement, misuse, abuse, neglect, accident, destruction or alteration of the serial number, improper electrical voltages or currents, repair, alteration or maintenance by any person or party other than our own service facility or an authorized Service Center, or any use violative of instructions furnished by us.

This one-year warranty is in lieu of all expressed warranties, obligations or liabilities. ANY IMPLIED WARRANTIES, OBLIGATIONS, OR LIABILITIES, INCLUDING BUT NOT LIMITED TO THE IMPLIED WARRANTIES OF MERCHANTABILITY AND FITNESS FOR A PARTICULAR PURPOSE, SHALL BE LIMITED IN DURATION TO THE ONE YEAR DURATION OF THIS WRITTEN LIMITED WARRANTY. Some states do not allow limitations on how long an implied warranty lasts, so the above limitation may not apply to you.

IN NO EVENT SHALL WE BE LIABLE FOR ANY SPECIAL, INCIDENTAL OR CONSEQUENTIAL DAMAGES FOR BREACH OF THIS OR ANY OTHER WARRANTY, EXPRESSED OR IMPLIED, WHATSOEVER. Some states do not allow the exclusion or limitation of special, incidental or consequential damages so the above limitation or exclusion may not apply to you. This warranty gives you specific legal rights, and you may also have other rights which vary from state to state.